

شركة عالم الصحة المتميزة الطبية World Health Excellence Medical Co.

Quality in equipment, precision in care



we care for life saving

Cardiology | Urology | Equipments | Respiratory | Anesthesia



info@whemd.com | www.whemd.com

Contents



Company Profile

Products



- **Urology**

- **Urology Endoscopy Equipment**



- **Cardiology**

- **Respiratory & Anaesthesia**



- **Medical Spare Parts**

- **Hospital Furniture & Surgical Infrastructure**



Global Partners

Contact Us

BLUENEEM

weseemed
medical technology

RELIS S

Multimedics
Devices for Life...

GaleMed

Besmed 

FORMED
for medical technology

UNDIS

VIAMED

PLINma
All For Reliable Vital Signs

medworld
better together

SAIKANG



Company Profile

In the world of healthcare, we take pride in our outstanding achievements in importing advanced medical equipment. We are committed to delivering the latest technologies that enhance the quality of healthcare services and contribute to the development of innovative medical solutions tailored to meet our customers' needs.

Explore Our Journey of Leadership and Excellence

We are a leading company in the field of importing and distributing medical equipment and supplies. Our strength lies in providing cutting-edge technologies and maintaining the highest standards of quality to serve the evolving needs of the medical sector.

With a strong commitment to excellence, we offer a comprehensive range of products and solutions designed to support healthcare providers and ensure effective, reliable, and outstanding patient care. Our dedication to innovation, quality, and customer satisfaction positions us as a trusted partner in advancing healthcare services.



Vision

To be a global life-sciences company transforming lives through pathbreaking discoveries.



Mission

To unlock new possibilities in life-sciences through quality healthcare solutions that impact lives.



Purpose

Empowering people with the freedom to live healthier and more full

***“Your Trusted Partner in
Our Services Healthcare Journey”***

- World Health Excellence Medical Company is a leading provider of specialized medical solutions, dedicated to advancing urological care through high-quality products.
- We offer an extensive and versatile range of urology items, specifically curated to enhance procedural precision and clinical efficiency across all subspecialties.
- Our Stenting & Navigation portfolio features D-J Stents (available in Short-term and Long-term configurations, with or without strings) and high-torque Guidewires including Hydrotwister, Prime, and PTFE-coated options.
- We provide a complete Access & Dilation Suite, including Ureteral and Amplatz Sheaths, along with Ureteral/Renal Dilator Sets with high-pressure Inflation Devices.
- Our Advanced Drainage solutions feature Suprapubic and Nephrostomy sets (including Direct Puncture and pigtail systems) and various types of Ureteral Catheters for specialized drainage.
- For Stone Management, we provide a wide array of Flexible Stone Baskets in multiple sizes, ensuring secure and atraumatic retrieval in both the ureter and kidney.
- We feature state-of-the-art Ureteroscopes and Cystoscopes equipped with high-resolution cameras and Laser-compatibility, optimized for both diagnostic and therapeutic interventions.
- These imaging systems are integrated with medical-grade Monitors, allowing for crystal-clear visualization and the ability to record procedures for documentation and review.
- Every product in our inventory is sourced from trusted manufacturers, meeting the highest international safety and medical standards.
- With a vast inventory covering everything from interventional consumables to advanced imaging towers, World Health Excellence Medical Company is your trusted partner for complete urological care.

P FLEX STENT SET WITH STRING

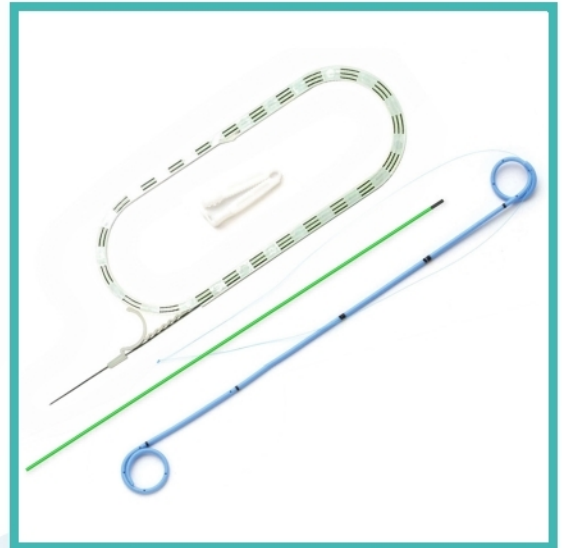

URETERAL ACCESS SHEATH



SUPRAPUBIC DRAINAGE CATHETER SET



STENTS

- P Flex Stent With String
(Ureteral Stent / Double J Stent)
- P Flex Stent Set With String
(Ureteral Stent Set / Double J Stent Set)

GUIDEWIRES

- PTFE Guidewire
- Hydro Twister™ Guidewire
- Tracer™ Guidewire
- Prime Wire™

CATHETERS

- Ureteral Catheter
- Suprapubic Catheter
- PCN Catheter with Locking Mechanism
- PCN Catheter with Needle
(Nephrostomy Drainage Set Direct Puncture)

DRAINAGE SETS

- PCN Set - Pigtail
- PCN Set - Pigtail with Locking Mechanism
- Suprapubic Drainage Catheter Set

DILATORS

- Urethral Balloon Dilator
- Urethral Dilator Set
- Urethral Dilator Set - S Curved
- Amplatz Sheath
- Amplatz Renal Dilation Set – S
- Amplatz Renal Dilator
(Renal Dilator with Amplatz Sheath)

STONE BASKETS

- Nitinol stone basket flexible
- Nitinol stone basket zero tip

URETERAL ACCESS SHEATH

- Praveza® Ureteral Access Sheath

NEEDLES

- Initial Puncture Needle – Two Part

NITINOL STONE BASKET FLEXIBLE



URETERAL BALLOON DILATOR

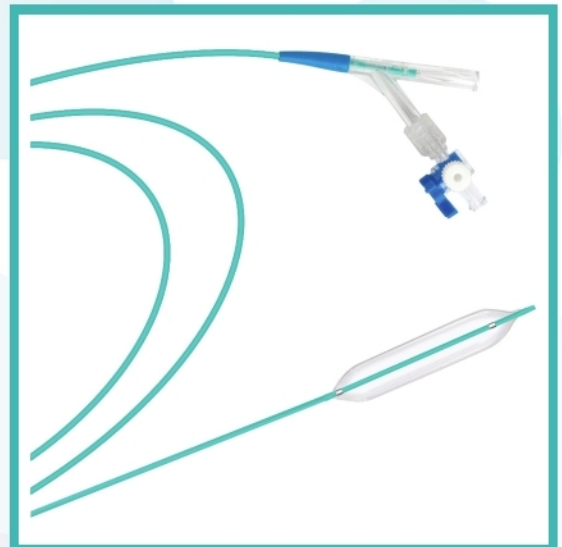

URETHRAL DILATOR SET - S CURVED

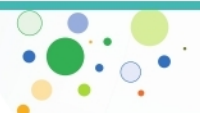
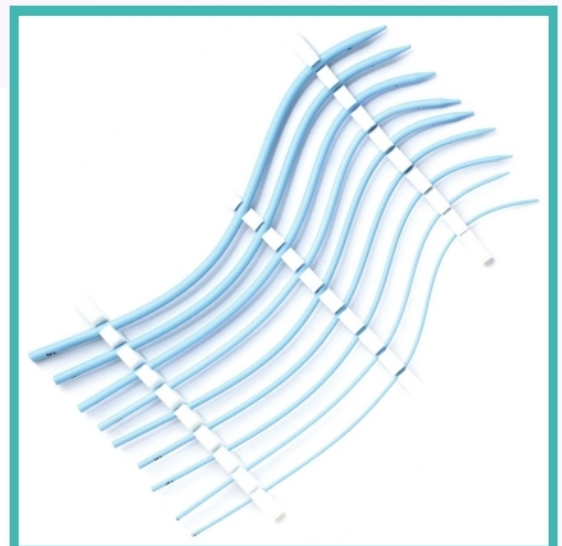

PCN SET - PIGTAIL WITH LOCKING MECHANISM



PRIME WIRE

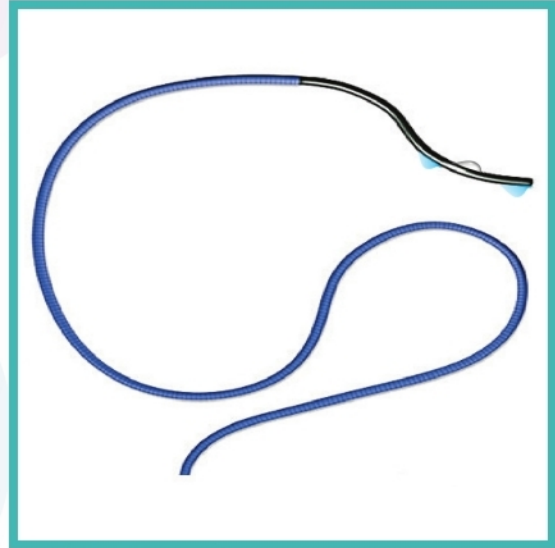

HYDRO TWISTER GUIDEWIRE)

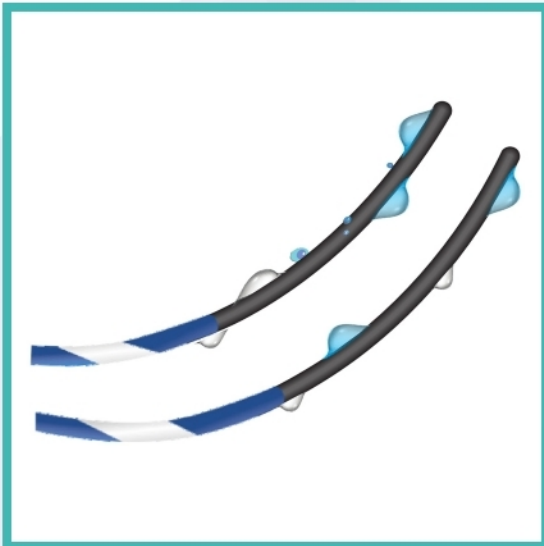

AMPLATZ RENAL DILATION SET - S

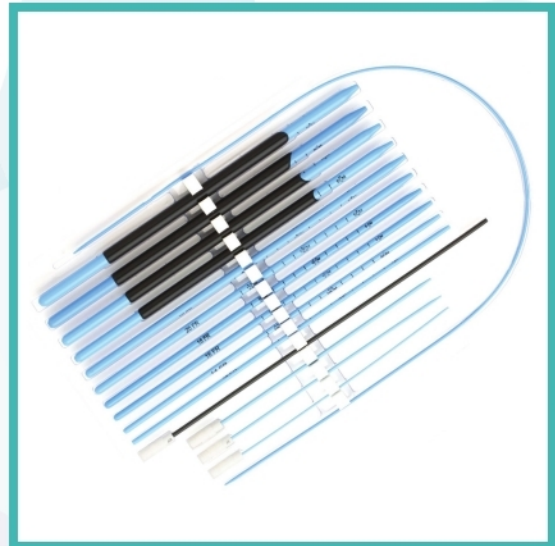

URETERAL CATHETER

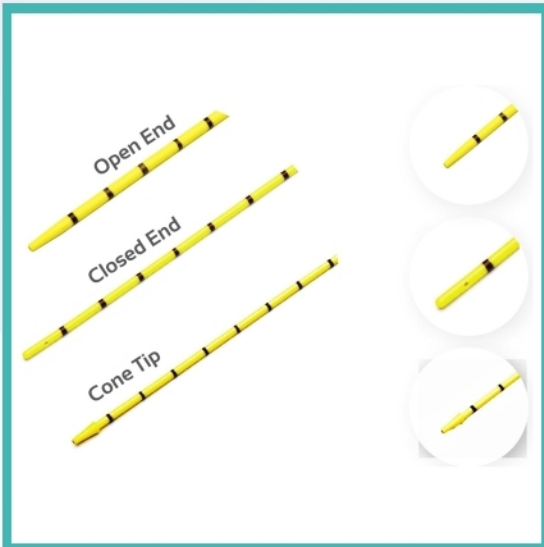

INITIAL PUNCTURE NEEDLE - THREE PART



RF14A Flexible Video Ureteroscope

- The RF14A flexible video ureteroscope is engineered for advanced minimally invasive diagnosis and treatment of the ureter and kidney.
- It delivers 160,000 ultra-clear HD imaging, with 110° field of view, 0° direction of view, and depth of field 3–50 mm for precise visualization.
- Designed with an 8.4/9.2 Fr slim insertion tube and 3.6 Fr working channel, it enables efficient access and instrument compatibility.
- Its 275° up/down angulation provides full coverage of the renal collecting system, enhancing maneuverability and procedural accuracy .
- Reusable and easy to sterilize, it supports video recording, brightness adjustment, and monitor integration, ensuring durability and reliable after-sales support.



RF13A Portable High-Definition Digital Cystoscope

- The RF13A flexible video cystoscope is designed for precise diagnosis and treatment of bladder and urethral conditions.
- It features HD image detection with 100° view angle, delivering clear and detailed visualization of mucosal structures.
- With outer diameter 4.9–5.5 mm and working channel 2.2–2.6 mm, it ensures patient comfort and efficient instrument use.
- The 210° up / 130° down bending capability allows smooth navigation and accurate examination of the lower urinary tract.
- Reusable with easy sterilization, it includes video recording, adjustable brightness, and monitor compatibility, backed by dependable after-sales service.





Product Structure



No.	Name of Spare Part	Application
1	Port of Connection Cable	Signal transmission
2	Angulation Lever	Controlling the angulation of bending section
3	Leakage Port	Sealing Check
4	Functional Buttons	Button 1: Zoom in/out (Hold) Brightness (Press) Button 2: Video Recording (Hold) Take Photos (Press)
5	Working Channel	For instruments or liquid



Product Structure

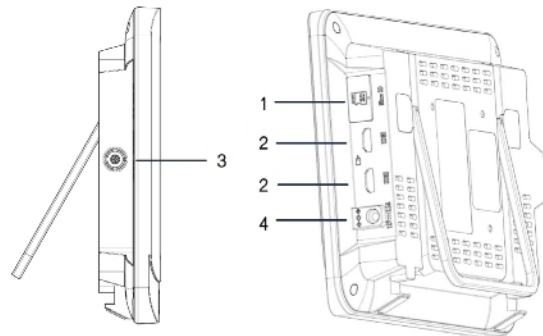





NO.	1	2	3	4
NAME	SD Card Port	HDMI Interface	Connection Cable Interface	Power Source cable Interface
APPLICATION	SD card inserted for the storage of pictures, recordings, or software upgrade	Connecting a monitor or other device equipped with an HDMI input interface to output HDMI video signals	Connecting with endoscope through video cable	charging the device

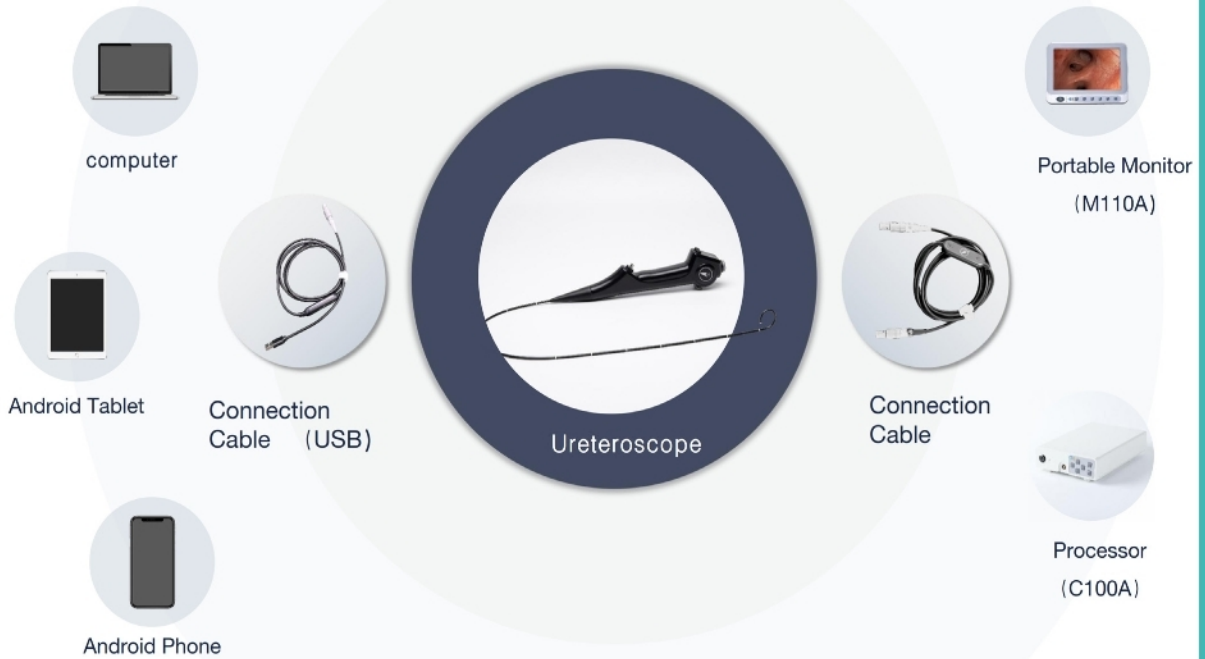

Connection Ways



Instruments Used During Procedure

-  • Laser
-  • Guidewire
-  • Double-J Stent
-  • Stone Retrieval Basket
-  • Luer Lock Valve



Products > Cardiology

- World Health Excellence Medical Company is a leading provider of specialized cardiovascular solutions, dedicated to advancing heart health through precision-engineered technology.
- We offer a comprehensive range of interventional cardiology devices, specifically designed to enhance procedural success and patient safety in high-stakes environments.
- The Stenting Portfolio features the M'Sure-S Sirolimus Eluting Coronary Stent, utilizing an ultra-thin $59\mu\text{m}$ cobalt chromium platform with a biodegradable polymer for optimal healing.
- This intelligent cell design provides excellent radial strength and flexibility, ensuring controlled Sirolimus release ($1.30 \mu\text{g}/\text{mm}^2$) for superior long-term outcomes.
- Our Balloon Angioplasty Suite features PEARL SC (Semi-Compliant) and PEARL NC (Non-Compliant) catheters, offering premium crossability and high-pressure performance.
- These catheters are engineered for superior trackability, allowing for seamless navigation through complex vascular anatomies and challenging lesions.
- The Diagnostic Access range includes Angiographic Catheters, offering exceptional torque control, shape memory, and kink resistance.
- Every diagnostic catheter is designed with a soft, atraumatic tip to ensure safe coronary engagement and maximum reliability during interventional procedures.
- All products are Certified and comply with the highest international safety standards, ensuring reliability within the rigorous regulatory framework of the SFDA.
- By combining a comprehensive portfolio of drug-eluting technology with premium diagnostic disposables, World Health Medical Excellence Company provides the precision you can trust for advancing cardiovascular care.



Products > Cardiology

Pearl Semi Complaint Balloon

(Pre Dilation Catheter)

- Next generation hydrophilic coatings with unmatched lubricity and low particulates.
- Designed with flexible tapered tip to guide the balloon catheter
- Extremely hump free fusion of distal tip, inner lumen and balloon cone help to cross lesions in tortuous anatomy.

Pearl Non Complaint Balloon (Post Dilation Catheter)

- Durable non complaint balloon designed to tackle multiple dilatation needs.
- Parallel guide wire exit port guarantees best pushability and better dye flow injection.
- Ultra-smooth transition area and lubricious hydrophilic coating for friction free performance.

Angiographic Diagnostic Catheter

- Feature a very soft, atraumatic tip that minimizes the vessel damage.
- Hydrophilic Coated Catheters 4Fr, 5FR, 6Fr designed for radial & femoral access of left & right coronary arteries and can withstand pressures upto 950 psi.
- Catheters are manufactured by a proprietary state of the art extrusion process which results in the construction of solid shaft thereby enhancing overall performance.

Sirolimus Eluting Coronary Stent

- Stent is Built on (59 cobalt chromium) platform and
- The special electro-polishing technique ensures an ultra-low strut thickness and 0.29% foreshortening & <3% recoil.
- Intelligent cell design provide optimal radial strength, high degree of flexibility and excellent scaffolding.

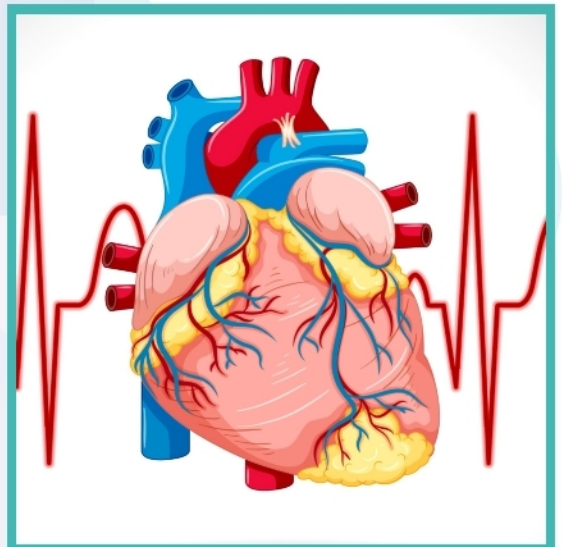
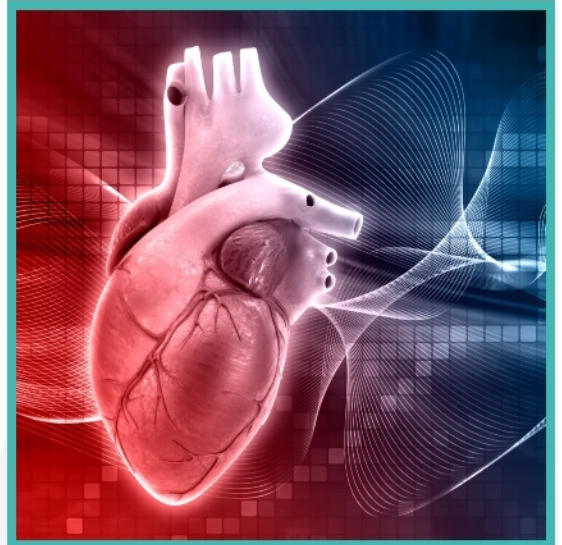

PEARL Semi Compliant / Non- Compliant Balloon

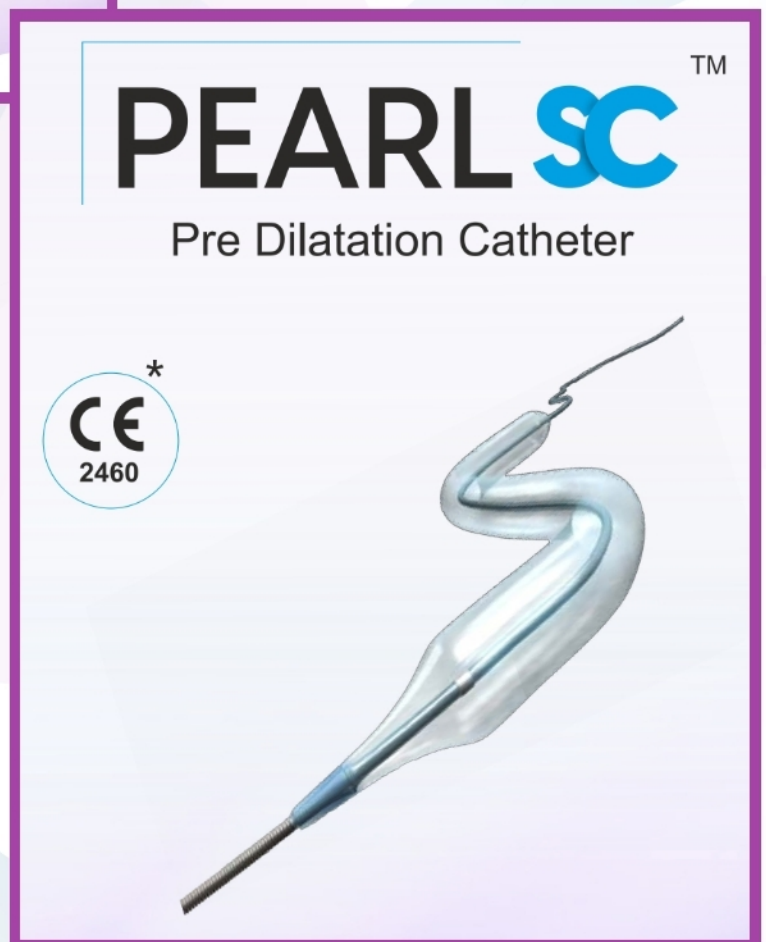
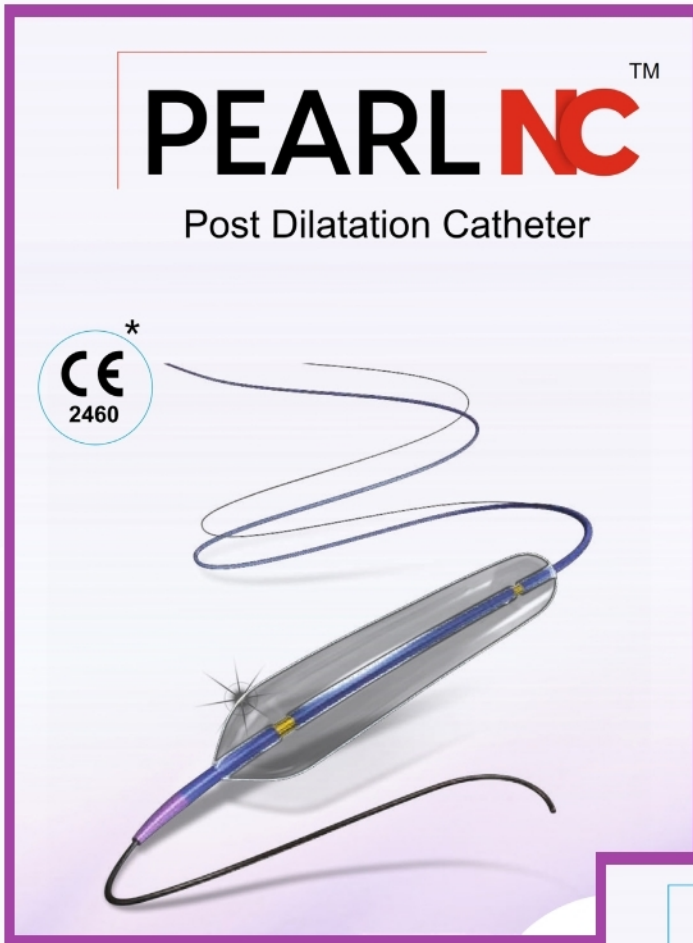

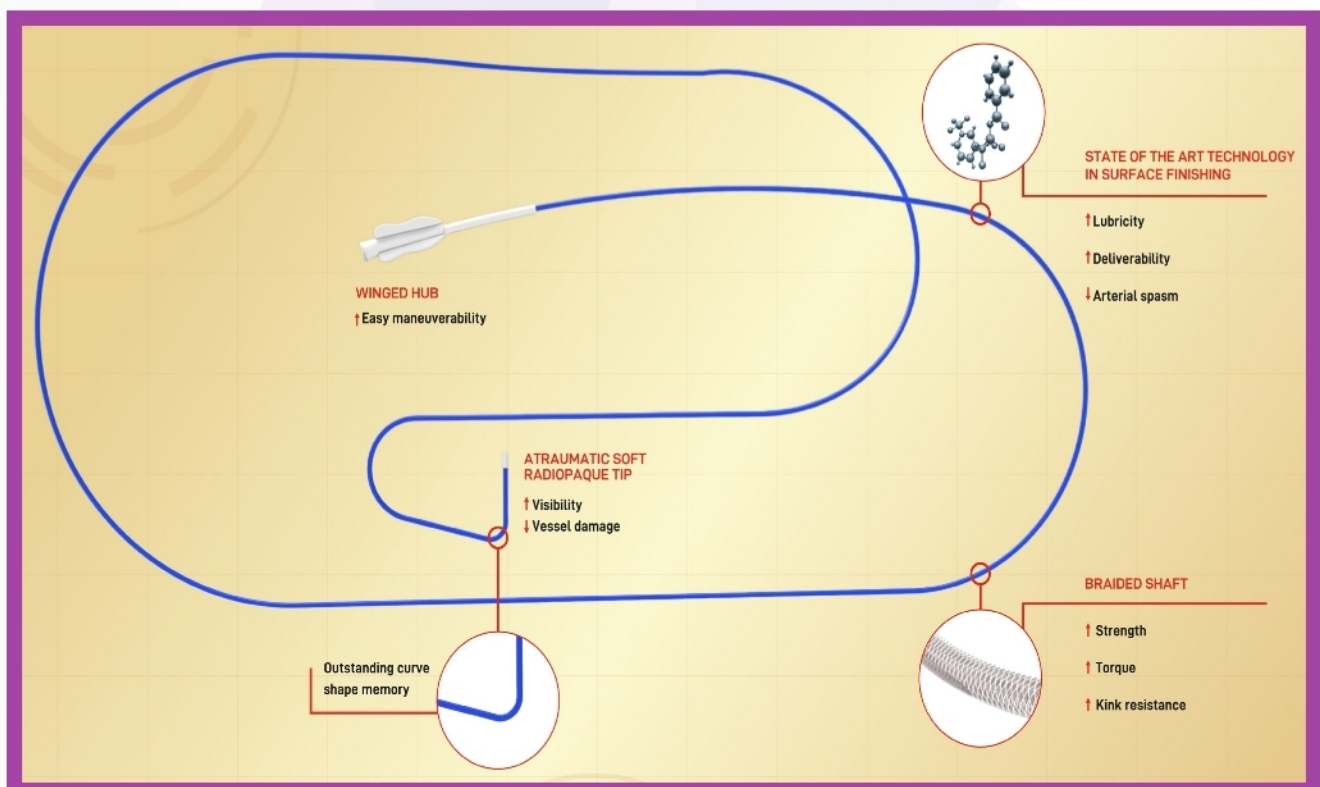
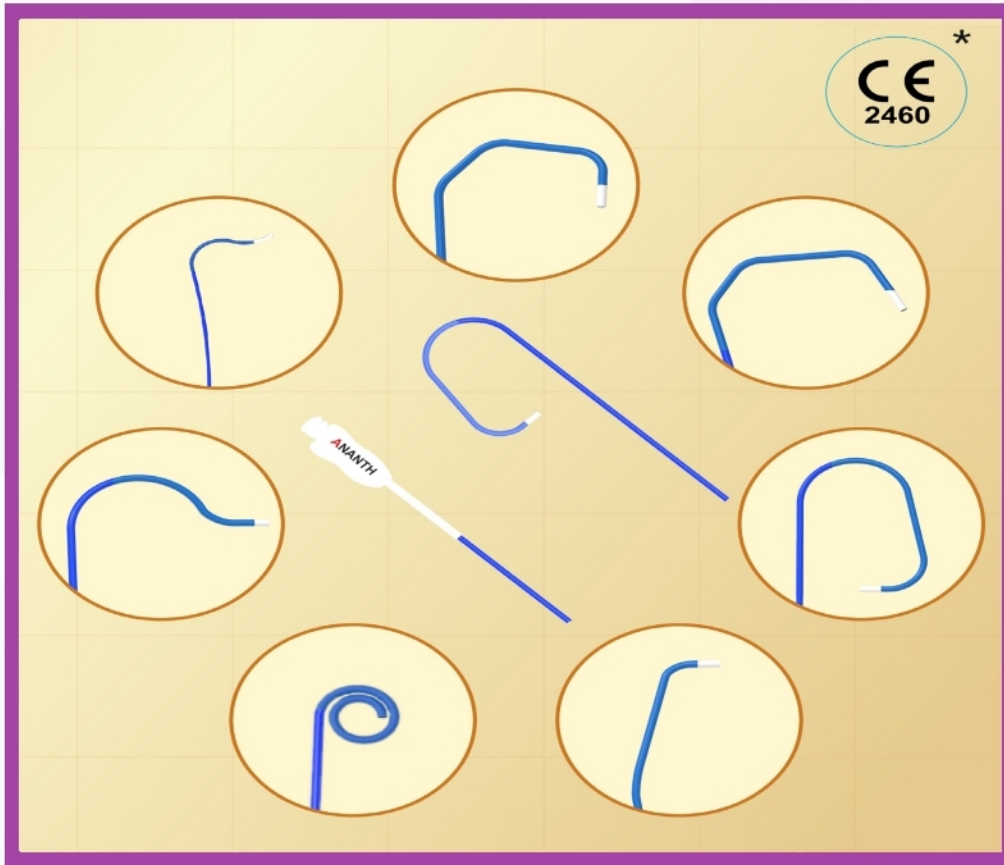

ANGIOGRAPHIC DIAGNOSTIC CATHETERS

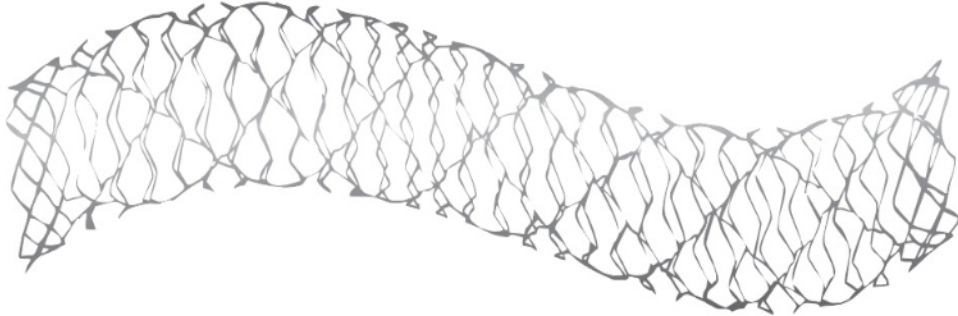

SIROLIMUS ELTUING CORONARY STENT

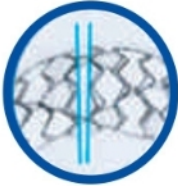

**Intelligent unique Stent design gives high degree of flexibility, excellent scaffolding, lesser chances of recoil and foreshortening and high radial strength**

**Low strut thickness of 59 μm + 2 μm of drug and polymer coating**

**Time tested sirolimus drug and bio compatible timed to release 30-40 days**

Intelligent design comprising of open and closed cells offers

High Radial Strength of 1.1 bar

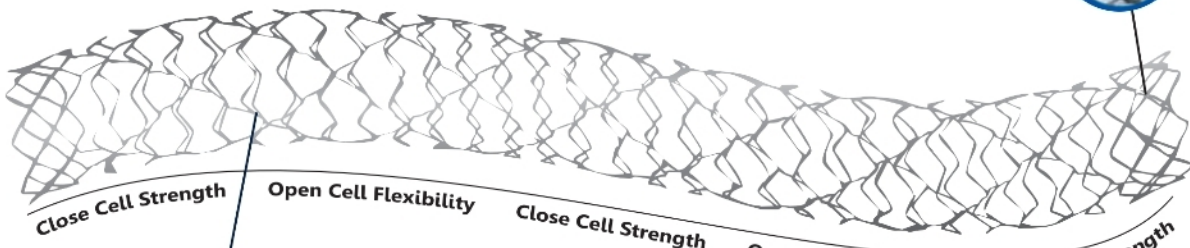

Close Cell Strength Open Cell Flexibility Close Cell Strength Open Cell Flexibility Close Cell Strength

 High Degree of Flexibility



Safety & Efficacy established by PRISM Basket of Clinical Trials.



Products > Respiratory & Anaesthesia

World Health Excellence Medical Company is a leading provider of life-critical solutions, dedicated to advancing Respiratory and Anesthesia care through high-precision breathing systems and advanced airway management products.

1. Advanced Respiratory Support

- Precision Ventilation Circuits: We specialize in high-performance breathing circuits compatible with industry-leading platforms such as SLE and Dräger, covering neonatal, pediatric, and adult requirements.
- Non-Invasive Excellence: Our range includes comprehensive HFNC (High-Flow Nasal Cannula) systems, featuring Ram cannulas, delivery circuits, and specialized nasal prongs.
- Enhanced Patient Interface: Offering a complete sizing range of bonnets and nasal interfaces to ensure a leak-free seal, which is critical for the success of CPAP and non-invasive therapy.
- Specialization: We provide dedicated respiratory solutions to ensure the patients receive stable and reliable support.

2. Comprehensive Anesthesia & Airway Management

- Integrated Breathing Systems: We offer a full spectrum of anesthesia circuits, latex reservoir bags, and high-efficiency filters designed for seamless integration into the modern surgical suite.
- Superior Airway Control: From standard ET tubes and Laryngeal Mask Airways (LMA) to advanced airway management tools, we ensure clinician confidence during every intubation.
- Patient Interface & Comfort: we features a diverse array of oxygen masks, catheter mounts, and ergonomic face masks, engineered to maintain circuit integrity and optimize gas delivery.
- Perioperative Safety: Supplying the "bridge" between the anesthesia machine and the patient, using high-quality products to maintain steady concentrations during procedures.

“we ensure that healthcare providers have the reliable, high-precision tools necessary to manage life-critical moments with total confidence”



RESPIRATORY

Circuits

- SLE Circuit (Neonate)
- Drager Circuit (Neonate)
- Universal Circuit (Neonate , Pediatric , Adult)

Non-Invasive

- Hi-inflow Nasal Cannula
- Ram Cannula
- Nasal Prongs
- Universal Generator

Bonnet

CPAP/BPAP Mask

Nebulizer Mask

HME Filters

ANAESTHESIA

- Anaesthesia Circuit
- Anaesthesia Mask
- Oxygen Mask
- Endotracheal Tube
- Lyrangeal Mask Airway
- Nesopharyngeal Airway
- Guedel Airway
- Catheter Mount
- Resuscitator Bag
- Non-Latex Bag



(H732 - S1 - Breathing Circuit W/Chamber)

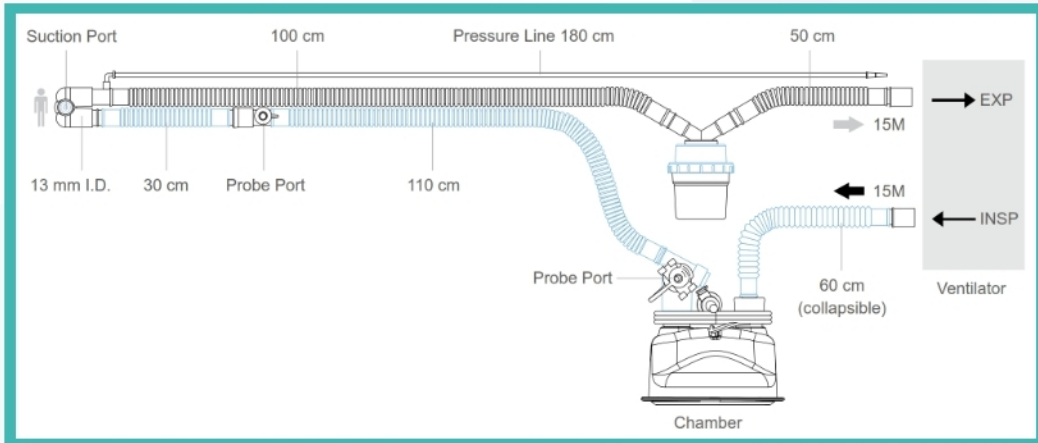

(H732 - D1 - Breathing Circuit W/Chamber)

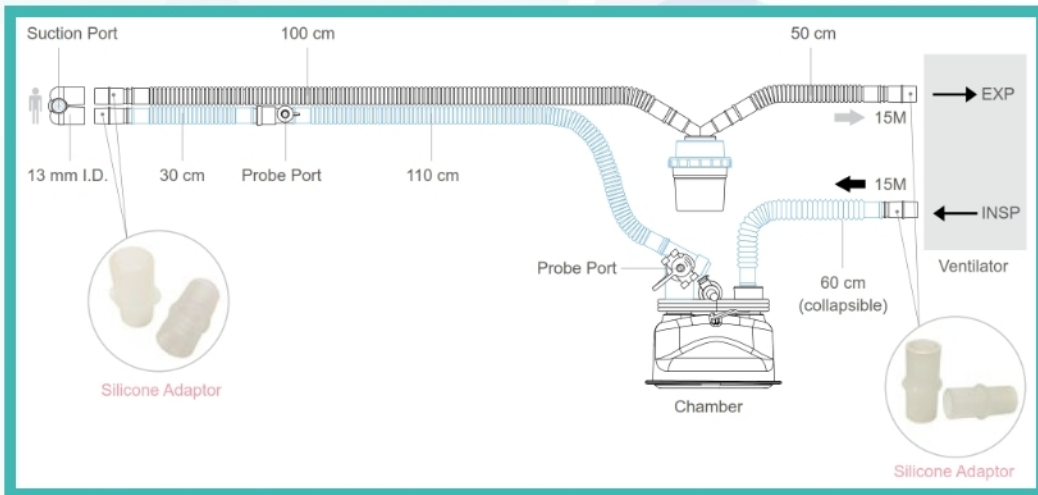

(H772 - Breathing Circuit W/Chamber)

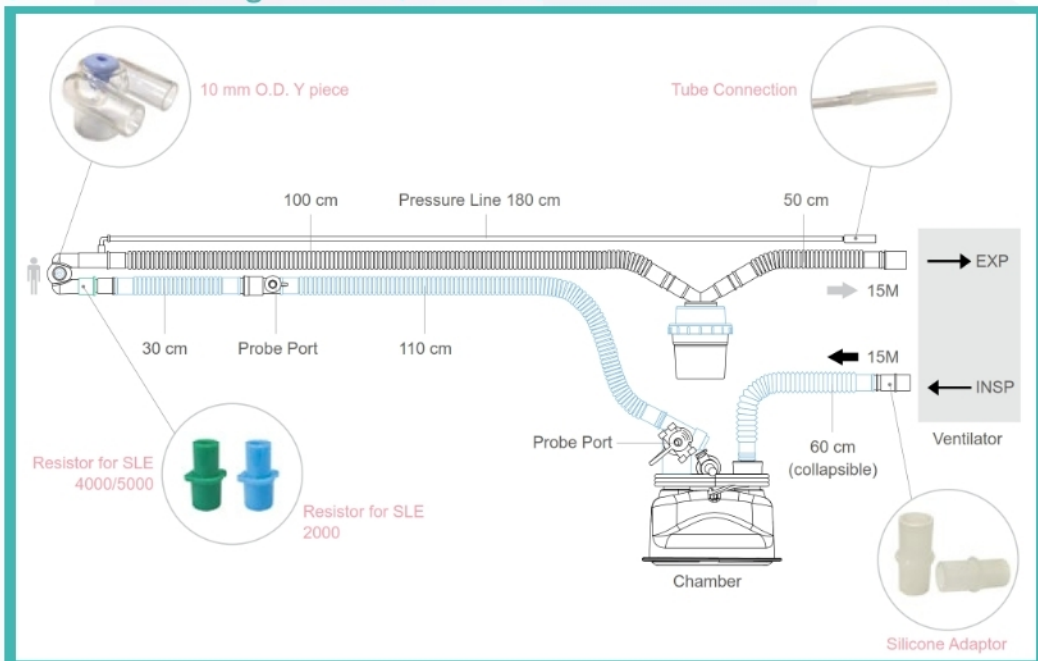

Products > Respiratory

Bonnet



ORO - NASAL MASK



UNIVERSAL GENERATOR

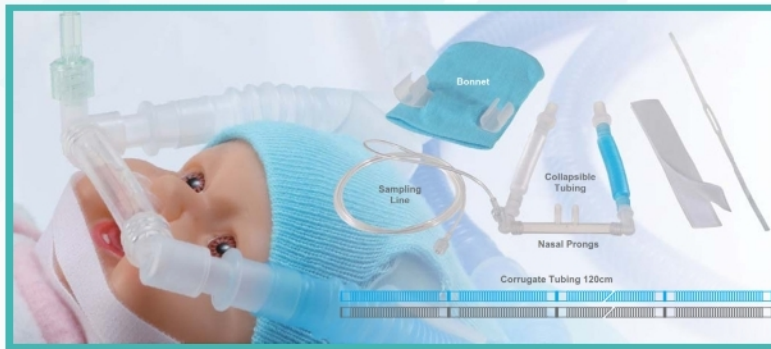

UNDIS[®]

HFNC



RAM CANNULA

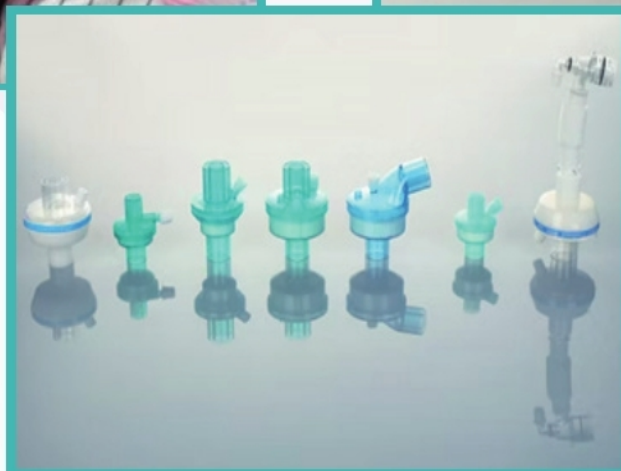

BACTERIAL FILTERS



Products > Anaesthesia

Anaesthesia Circuit



Nasopharyngeal Airway



Oxygen Mask



Catheter Mount



ET Tube



Guedel Airway



Resuscitator Bag



LMA

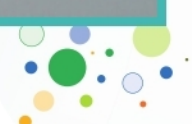

Products > Medical Spare Parts

- Our Technical Domain: World Health Excellence Medical Company is a trusted source for high-calibration spare parts, specializing in Oxygen Sensors, Oxygen Cells, and Flow Sensors—the "lungs" of respiratory equipment.
- Power & Connectivity: We ensure zero-downtime operations by supplying medical-grade Batteries, robust Boards, and high-fidelity Flow Sensor Cables for various diagnostic and ventilation platforms.
- Precision Values: Our commitment is to Technical Accuracy, sourcing only certified parts that guarantee the correct calibration and longevity of your hospital's high-value assets.
- Reliability Redefined: By bridging the gap in the supply chain for sensitive electronics and sensors, we empower biomedical departments to maintain a safe and functional clinical environment.



MEDICAL SPARE PARTS List

- Batteries
- Oxygen Sensors
- Oxygen Cells
- Flow Sensors
- Flow Sensors Cable
- Boards



Products >

Hospital Furniture & Surgical Infrastructure

- The Architecture of Care: Modern healthcare requires an environment that balances patient comfort with extreme clinical functionality; our furniture range is the backbone of that infrastructure.
- Specialized Patient Platforms: We provide advanced Electric ICU Beds, Child Beds, and Obstetric Beds, each designed to provide maximum safety and ease of positioning for specialized patient needs.
- Surgical & Procedure Excellence: Our portfolio features high-performance Electric Operating Tables and O.R. Lights, engineered to provide surgeons with the stability and visibility required for complex procedures.
- Patient Comfort & Ergonomics: From Electric Dialysis Chairs and Blood Donor Chairs to Electric Examination Tables, we prioritize ergonomic designs that reduce patient anxiety and staff fatigue.
- Integrated Ward Solutions: Our durable Medical Trolleys and mobile units ensure that essential supplies are always within reach, optimizing the workflow and hygiene standards of the modern medical facility.

V8v ELECTRIC ICU BED (SKD-C)



CX2x TWO FUNCTIONS CHILDREN BED (SK-C2)



Patient Transportation Trolley



Hospital Furniture List

- ICU Bed
- Child Bed
- Electric Examination Table
- Electric Operating Table
- Electric Dialysis Chair
- Blood Donor Chair
- Electric Obstetric Bed
- Medical Trolley
- O.R Lights



Products > Hospital Furniture & Surgical Infrastructure

ELECTRIC OPERATION TABLE



SKR-MT606 MEDICINE TROLLEY



SKE - 136 ELECTRIC DALYSIS CHAIR



A99-13 ELECTRIC OBSTETRIC BED



SKE - 091 BLOOD DONATION CHAIR



OR LIGHTS





Partners & Manufacturers

UROLOGY

BLUENEEM

UROLOGY DEVICE

 **weseeemed**
medical technology

CARDIOLOGY

 **Multimedics**
Devices for Life...

RELIS S

RESPIRATORY

GaleMed

Besmed 

 **FORMED**
for medical technology

ANAESTHESIA

UNDIS

MACHINES PARTS

 **VIAMED**

PLINma
All For Reliable Vital Signs

 **medworld**
better together

FURNITURE

SAIKANG



شركة عالم الصحة المتميزة الطبية
World Health Excellence Medical Co.
Quality in equipment, precision in care

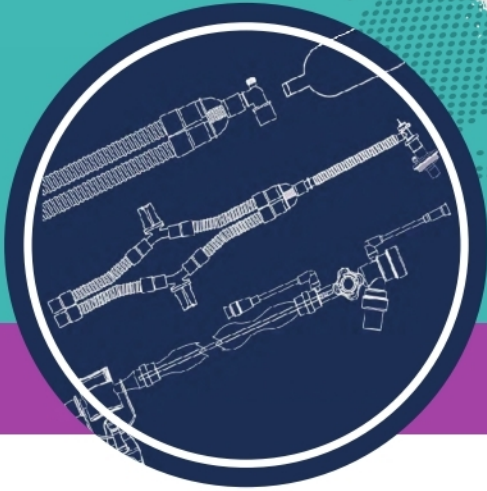

we care for life saving

Tel.: 13 807 1709, Mob: +966 54 466 4011
P.O. Box No. 38928, Al Khobar 31942, Saudi Arabia

info@whemd.com | www.whemd.com